

GoodWe Inverter Integration Guide

V3.5 - November 2024

Read this first	2
How are Goodwe Inverters integrated with the CET system?	2
When is a data connection to an Inverter required?	2
Is a Goodwe meter also required?	2
Selecting a data connection type	3
Battery Configuration	4
The CET device should be powered from the backup circuit	6
Contact CET Support to test the data connection	6
Steps to Connect to Inverter	7
Inverter Ethernet Connection	7
Inverter RS485 Connection	8
Connecting multiple inverters on the same RS485 bus	8
DNS / NS / TDS Series	9
DNS G3 Series (DNS-30)	10
DT Series	11
DT Series Style 1 - Terminal block under Wi-Fi cover	11
DT Series Style 2 - Two-position "COM" connector	14
DT Series Style 3 - 6 position "COM2" connector	15
EH / EH Plus Series	16
EM Series	17
ES Series	18
ES G2 Series (ES-20)	19
ET Series	20
ET Series Style 1 - Cable Gland Entry for RS485	21
ET Series Style 2 - Large 18-pin Connector for RS485	22
ET Series Style 3 - 15kW-30kW Models	23
HT Series	24
MS Series	25
MS G3 Series (MS-30)	27
MT (30kW and lower) and SMT Series	28
MT Series (50kW and higher)	29
SBP Series	30
SBP G2 Series (SBP-20)	31
XS Series (0.7-3kW)	32
Steps to Connect to CET Device	33
Power Meter (EMU system)	33
Ethernet	33
RS485	34
PM2 RS485 Filter for Goodwe DNS and ES G2 (ES-20) Inverters	35
Gateway One	37
Ethernet	37
RS485	38

Read this first

How are Goodwe Inverters integrated with the CET system?

Goodwe Inverters are integrated with the CET system by adding a data connection between the CET device (Gateway One / Power Meter / etc) and the Inverter.

Example of old system (Gateway One)

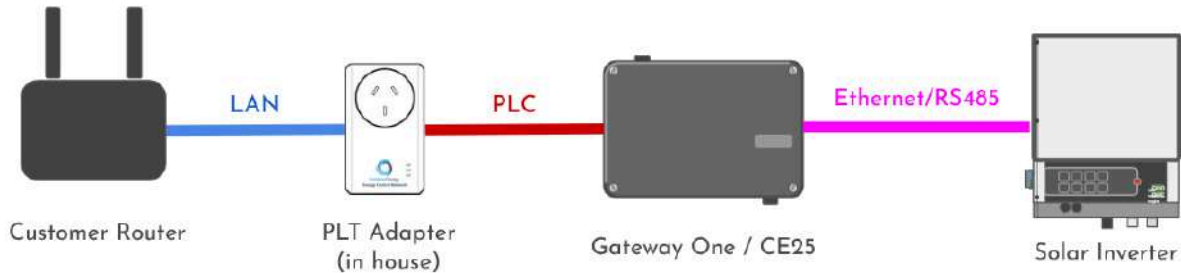

Example of new system (EMU + Power Meter)

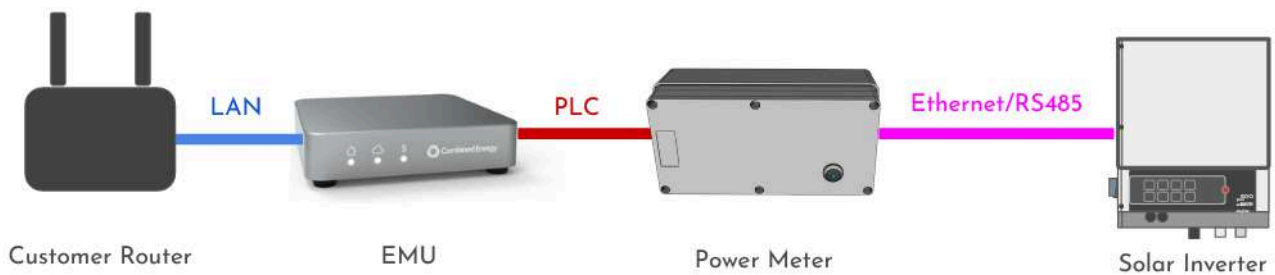

When is a data connection to an Inverter required?

1. When the CET system is responsible for export limiting
2. When there is a battery connected to the Inverter

Is a Goodwe meter also required?

No - the CET system performs all of the functions that would otherwise be done by the Goodwe meter.

Selecting a data connection type

1. Ethernet (**hybrid inverters only**)

Connecting an inverter using Ethernet provides the required Modbus data connection for the CET system to control the inverter, and also provides the Inverter with an Internet connection without needing to separately configure Wi-Fi.

The GOODWE WIFI/LAN BOX accessory is required for this option:



Please see the [Inverter Ethernet Connection](#) section of this document for details.

IMPORTANT: Please ensure Modbus TCP is supported for the inverter on site, and verify whether WIFI/LAN BOX version 1.0 or 2.0 will be required.

2. RS485

An RS485 connection provides a Modbus data connection for the CET system. This option does **not** also give the inverter a connection to the Internet.

The RS485 connection details depend on the inverter model - please refer to the [Inverter RS485 Connection](#) section of the document for details.

It is possible to connect up to two Goodwe inverters on the same RS485 bus (i.e. connected to the same CET device), please see the [Connecting Multiple Inverters on the same RS485 bus](#) section for details.

Battery Configuration

Please refer to the Goodwe documentation for the latest instructions on configuring a battery. Once the battery has been properly configured, the CET system will be able to use the data connection to control the battery.

On the Safety Area page



- QLD users should select “Australia EnergeX” or “Australia Ergon”
- WA users should select “Australia WA”
- All others should select “Australia”

Click “Next”.

NOTE: In updated versions, “Australia” etc may appear under “Oceania”.

Select 'General Mode' for to ensure the CET system can control the battery.

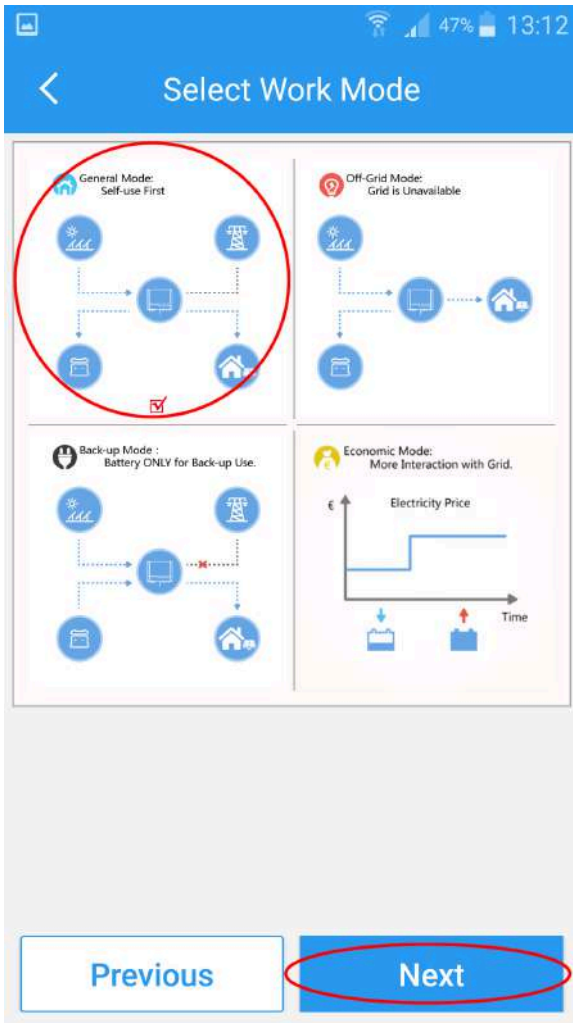

The CET device should be powered from the backup circuit

If a hybrid inverter with battery is being installed, the CET device (Gateway / Power Meter / etc) should be powered from the backup circuit so that it will continue to operate during blackouts.

If a single-phase backup is being provided at a two-phase or three-phase site, the backed up circuit should be connected to the **Phase A** terminal of the CET device.

Contact CET Support to test the data connection

When the data connection to the inverter is ready to test, contact CET by logging in to the *onSite* web app at <http://onsite.combined.energy/> and using the **Request Support** button in the menu.

Steps to Connect to Inverter

Inverter Ethernet Connection

These steps apply to all supported **GoodWe hybrid inverter** models:

1. Connect the GOODWE WIFI/LAN BOX to the USB port on the bottom face of the inverter:



2. Prepare a **double-insulated** Ethernet cable with a standard T568A or T568B pinout at both ends.
3. Connect the Ethernet cable to the GOODWE WIFI/LAN BOX.
4. Connect the Ethernet cable to the CET device in accordance with the specific steps for the device in the [Inverter Ethernet Connection](#) section of this document.

Inverter RS485 Connection

Please refer to the steps for the specific inverter series being used below. In all cases, the data cable used should be double-insulated and have twisted-pair cores (e.g. Clipsal 5005C305B).

Connecting multiple inverters on the same RS485 bus

It is possible to connected up to two Goodwe inverters on the same RS485 bus (i.e. connected to the same CET device), but the Modbus address of **both inverters** must be changed:

Inverter 1: Change address from 247 to **246**

Inverter 2: Change address from 247 to **245**

Note that Modbus address 247 is a 'broadcast' address that will respond to all addresses, so it can not be used.

DNS / NS / TDS Series

1. Remove the **WiFi Module cover** from the inverter to access the inverter's RS485 connector:

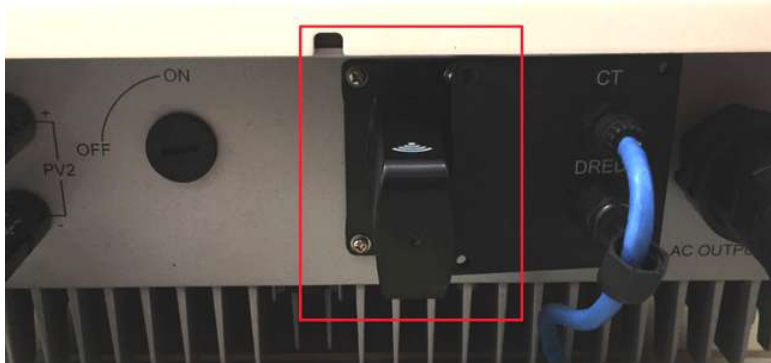

2. Connect the RS485 wires to the 2-position green block terminal supplied with the inverter as shown below. The brown wire (RS485+) should be connected to the position **closest to the USB connector**:



3. Terminate the CET device end of the cable in accordance with the [Steps to Connect to CET Device](#) section of this document.

DNS G3 Series (DNS-30)

4. Terminate the brown (RS485+) wire in position 1 of the RS485 2-pin connector, and brown-white (RS485-) in position 2.

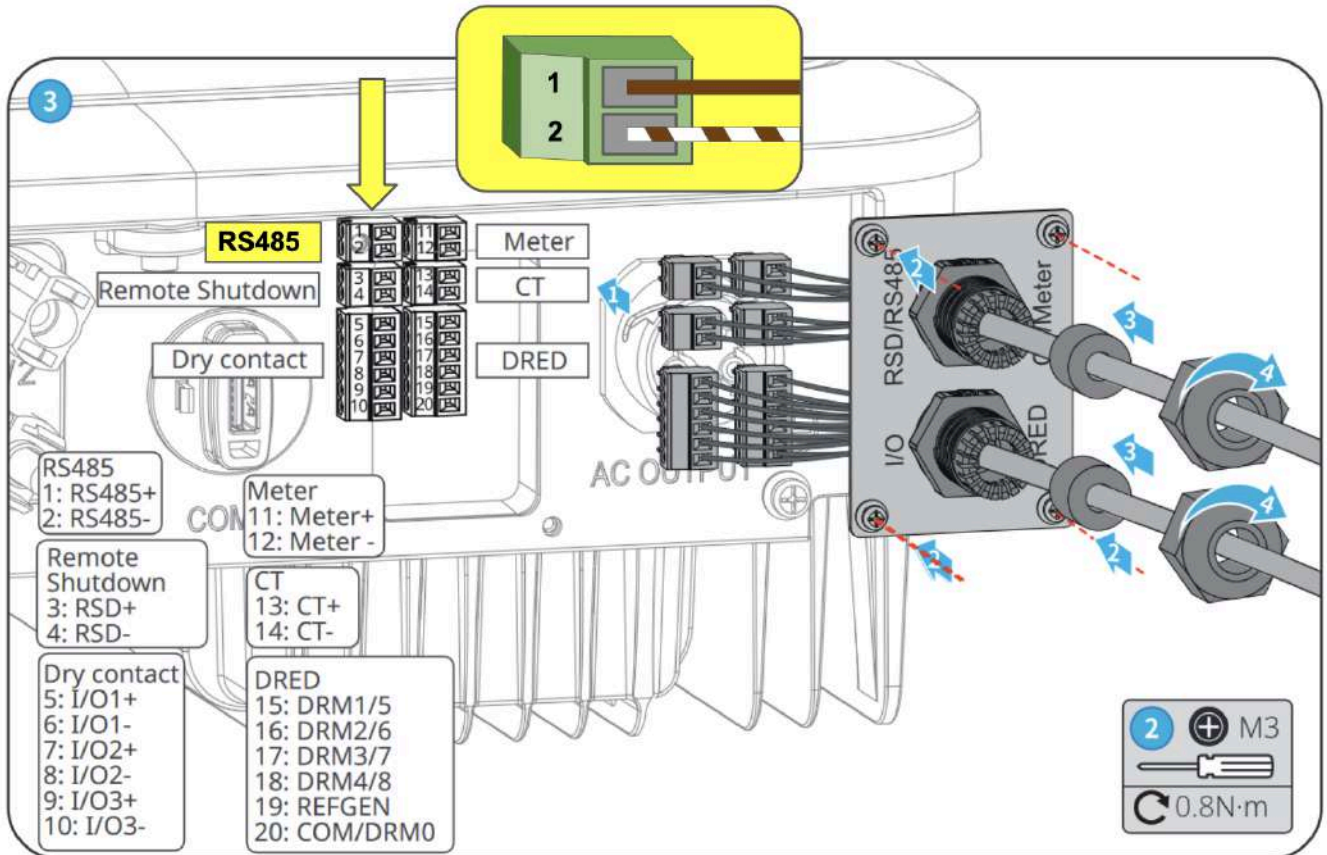

5. Terminate the CET device end of the cable in accordance with the [Steps to Connect to CET Device](#) section of this document.

DT Series

DT Series GoodWe inverters come in a number of different styles/models, each with a unique RS485 termination methodology. Check which of the photos below most closely matches your inverter before proceeding:

Style 1 - Terminal block under Wi-Fi cover

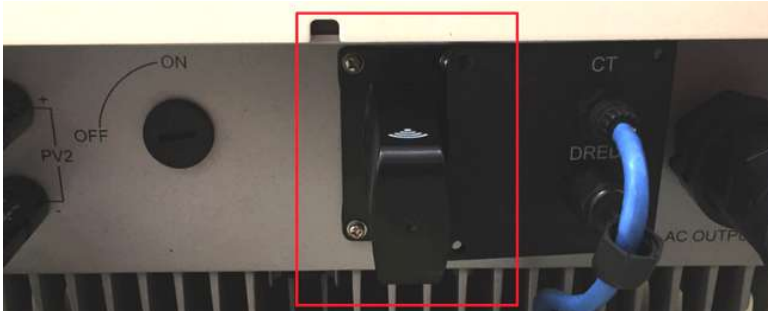

Style 2 - Two-position "COM" connector



Style 3 - 6 position "COM2" connector



DT Series Style 1 - Terminal block under Wi-Fi cover

1. Remove the **Wi-Fi Module cover** shown in the red square below:

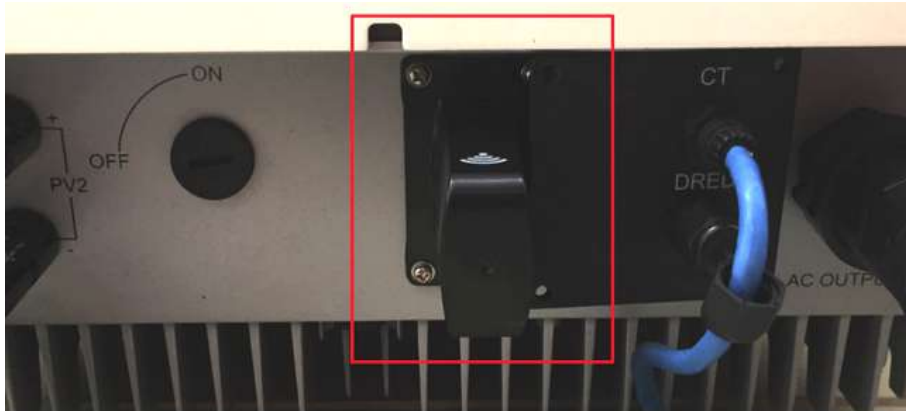

2. Connect the brown and brown-white wires to the green screw connector and plug the connector into the inverter in the correct position (compare your inverter with the **Variant A** and **Variant B** options below to identify the correct connector):.

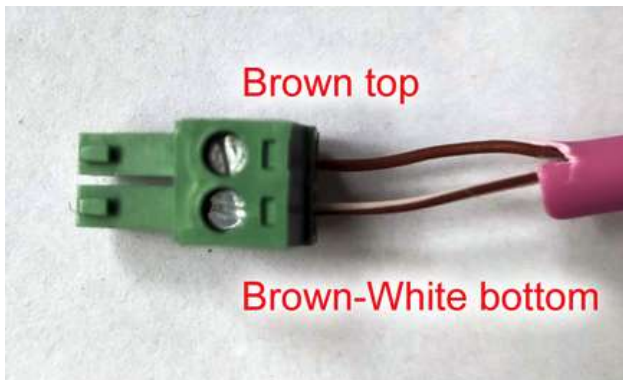

Variant A: 6-position header next to USB socket

The **brown** wire (RS485+) should be connected to the position closest to the USB connector:

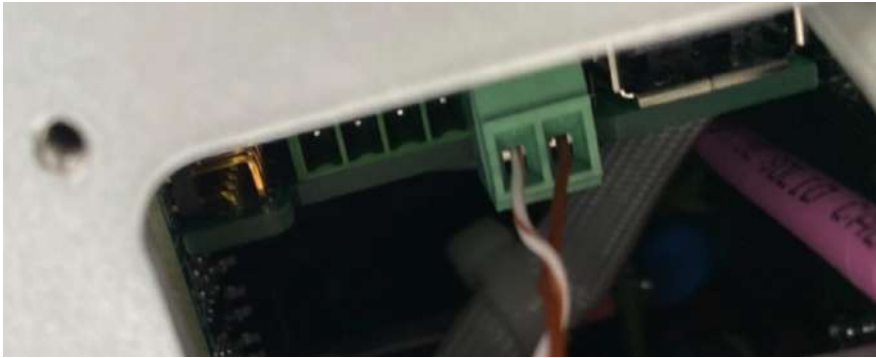

Variant B: 2-position header

The **brown-white** wire (RS485+) should be connected to the position closest to the USB connector:

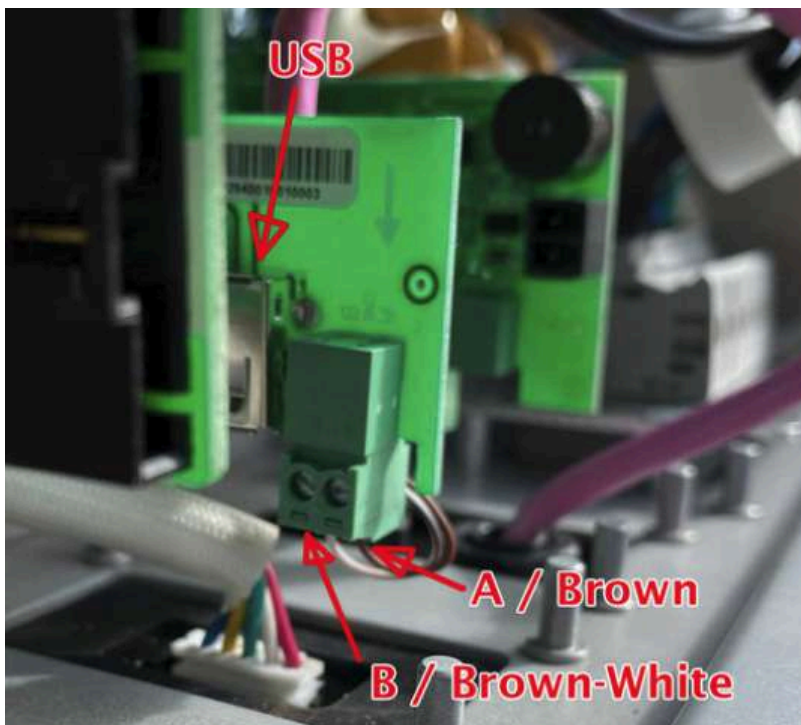

3. Terminate the CET device end of the cable in accordance with the [Steps to Connect to CET Device](#) section of this document.

DT Series Style 2 - Two-position "COM" connector

1. Terminate the RS485 wires into the supplied "COM" connector:



2. The pinout is:
 - **Brown wire** - "Meter +"
 - **Brown-white wire** - "Meter -"



3. Terminate the CET device end of the cable in accordance with the [Steps to Connect to CET Device](#) section of this document.

DT Series Style 3 - 6 position "COM2" connector

1. Find the connector with the RS485 terminals by checking the pinout card supplied with the inverter:



Some versions of the 10kWDT Inverters have two COM ports. The right-hand port often labeled "**COM2**" is the one with the RS485 pins:



2. The recommended pinout is:
 - **Brown wire** -> Pin 3 "RS485-A"
 - **Brown-white wire** -> Pin 1 "RS485-B"
3. Terminate the CET device end of the cable in accordance with the [Steps to Connect to CET Device](#) section of this document.

EH / EH Plus Series

1. Connect to the RJ45 port under the Back-Right **RS485 Communications** port (10):

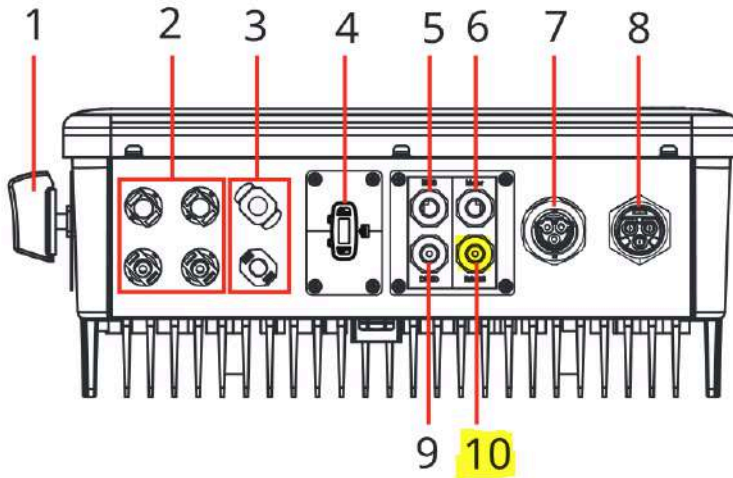

It is strongly recommended to crimp a new cable (using Clipsal 5005C305B pink double-insulated data cable) rather than using the existing gray cable that is shipped with the inverter. The GoodWe-supplied cable has a non-standard pinout which can cause confusion.

2. Use the pinout shown below on the RJ45 connector at the inverter end of the cable:

Goodwe Inverter

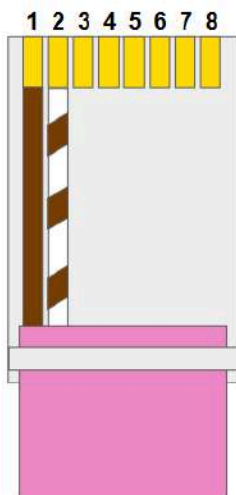

3. Terminate the CET device end of the cable in accordance with the [Steps to Connect to CET Device](#) section of this document.

EM Series

1. Use the Back-Right port marked “Reserved RS485” / “EMS”:

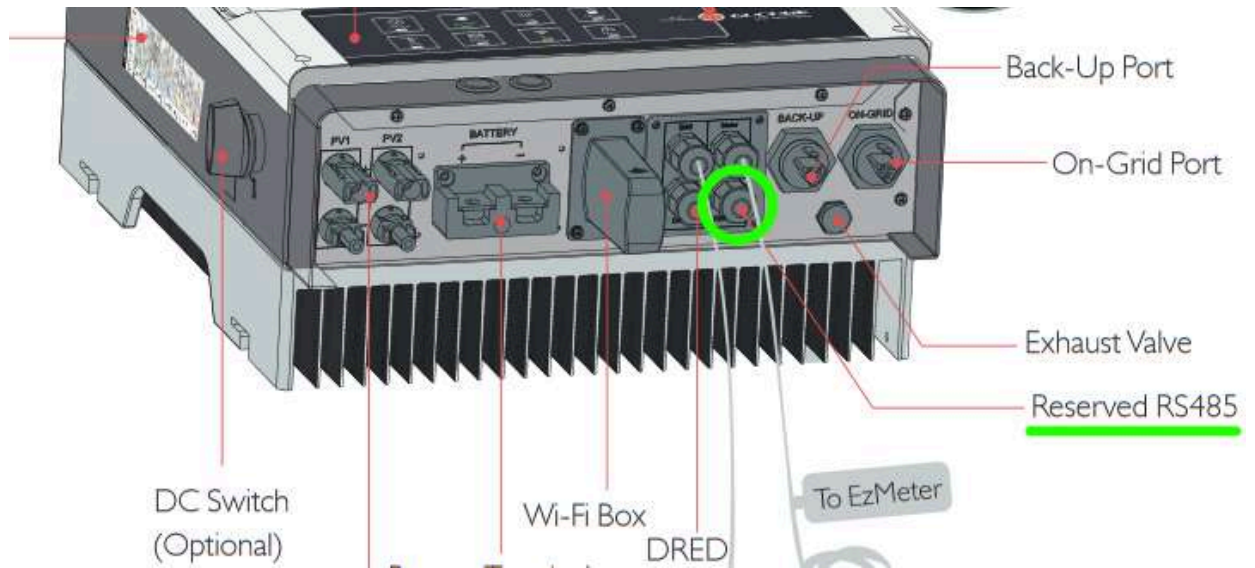

It is strongly recommended to crimp a new cable (using Clipsal 5005C305B pink double-insulated data cable) rather than using the existing gray cable that is shipped with the inverter. The GoodWe-supplied cable has a non-standard pinout which can cause confusion.

2. Use the pinout shown below on the RJ45 connector at the inverter end of the cable:

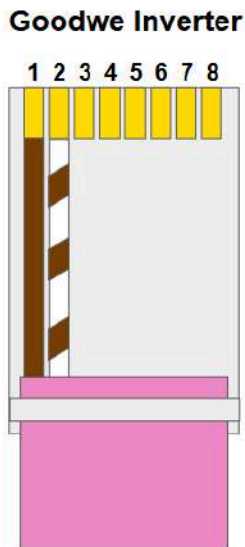

3. Terminate the CET device end of the cable in accordance with the [Steps to Connect to CET Device](#) section of this document.

ES Series

1. Use the Front-Right port marked “Reserved RS485” / “EMS”:

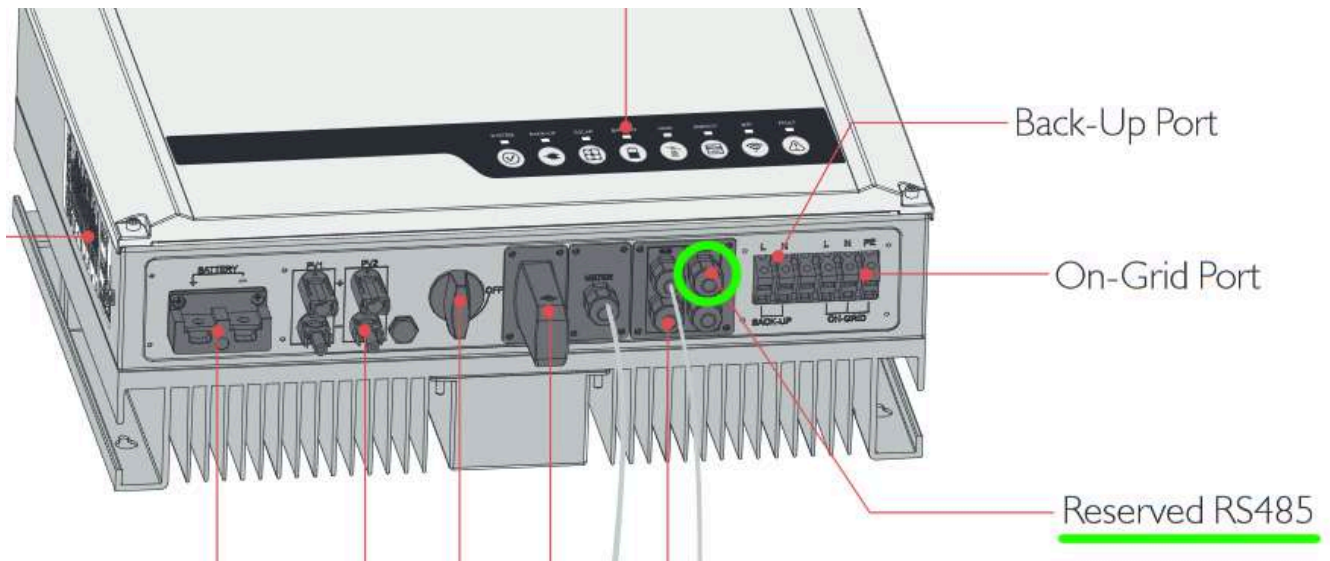

It is strongly recommended to crimp a new cable (using Clipsal 5005C305B pink double-insulated data cable) rather than using the existing gray cable that is shipped with the inverter. The GoodWe-supplied cable has a non-standard pinout which can cause confusion.

2. Use the pinout shown below on the RJ45 connector at the inverter end of the cable:

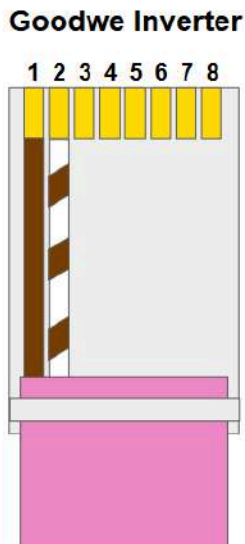

3. Terminate the CET device end of the cable in accordance with the [Steps to Connect to CET Device](#) section of this document.

ES G2 Series (ES-20)

1. Open the **COM2** panel on the bottom of the inverter and locate the two EMS/PAR RJ45 sockets:

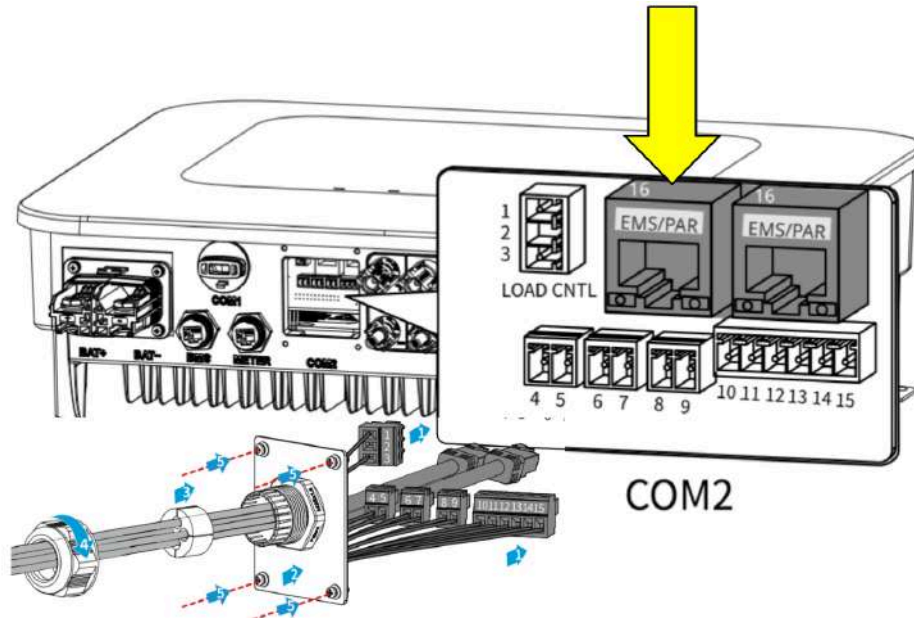

2. Use the pinout shown below on the RJ45 connector at the inverter end of the cable, and plug into one of the two EMS/PAR ports. It is strongly recommended to crimp a new cable (using Clipsal 5005C305B pink double-insulated data cable) rather than using the existing gray cable that is shipped with the inverter:

Goodwe Inverter

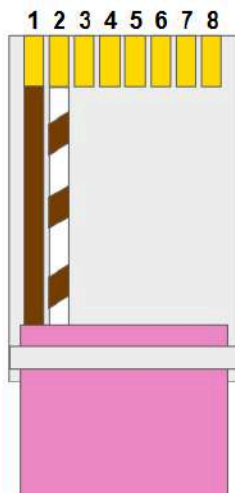

3. Terminate the CET device end of the cable in accordance with the [Steps to Connect to CET Device](#) section of this document.

ET Series

The ET Series comes in three different styles:

Style 1 - Cable Gland Entry for RS485

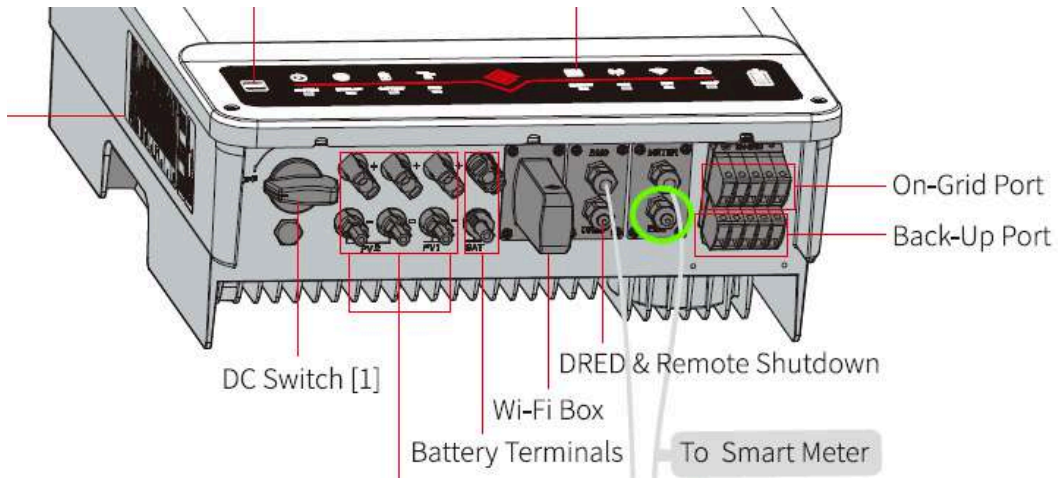

Style 2 - Large 18-pin Connector for RS485



Style 3 - 15kW-30kW Models



ET Series Style 1 - Cable Gland Entry for RS485

1. Connect to the RJ45 port under the Back-Right entry marked “EMS”:

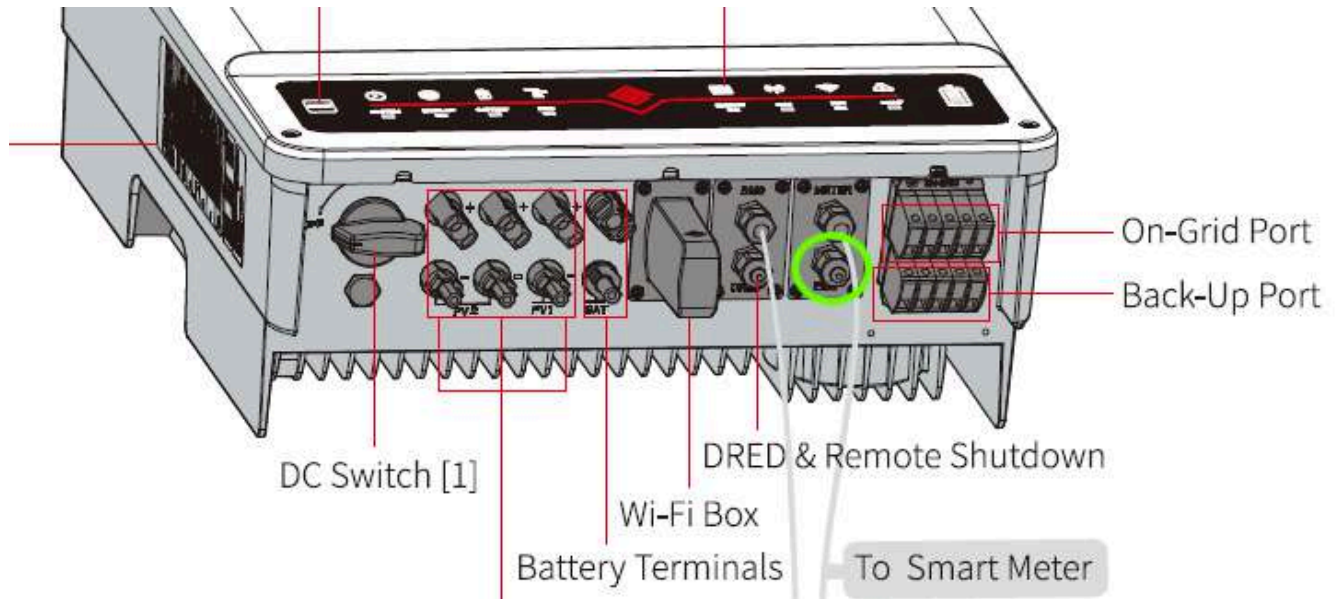

It is strongly recommended to crimp a new cable (using Clipsal 5005C305B pink double-insulated data cable) rather than using the existing gray cable that is shipped with the inverter. The GoodWe-supplied cable has a non-standard pinout which can cause confusion.

2. Use the pinout shown below on the RJ45 connector at the inverter end of the cable:

Goodwe Inverter

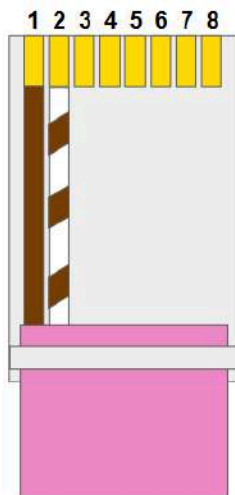

3. Terminate the CET device end of the cable in accordance with the [Steps to Connect to CET Device](#) section of this document.

ET Series Style 2 - Large 18-pin Connector for RS485

1. Terminate RS485 A into pin 1, RS485 B into pin 2 of the 18-pin connector on the ET Series Inverter:

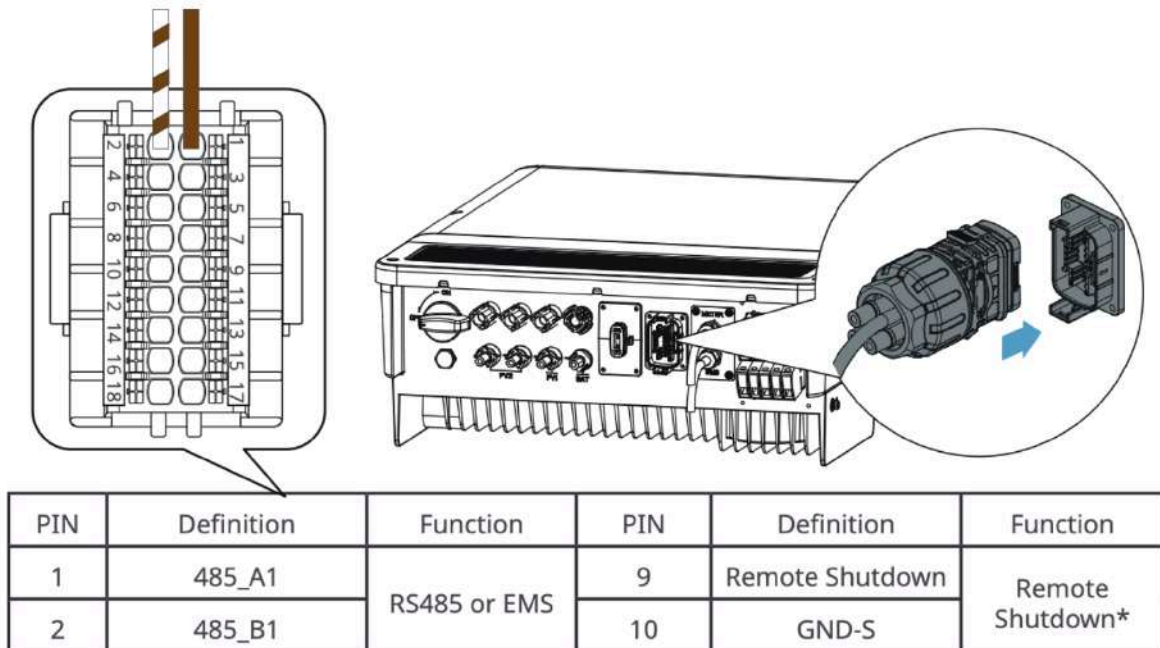

2. Terminate the CET device end of the cable in accordance with the [Steps to Connect to CET Device](#) section of this document.

ET Series Style 3 - 15kW-30kW Models

1. Run a double-insulated data cable through the COM2 connector and terminate the RS485 connection at one of the two EMS/PAR connectors:

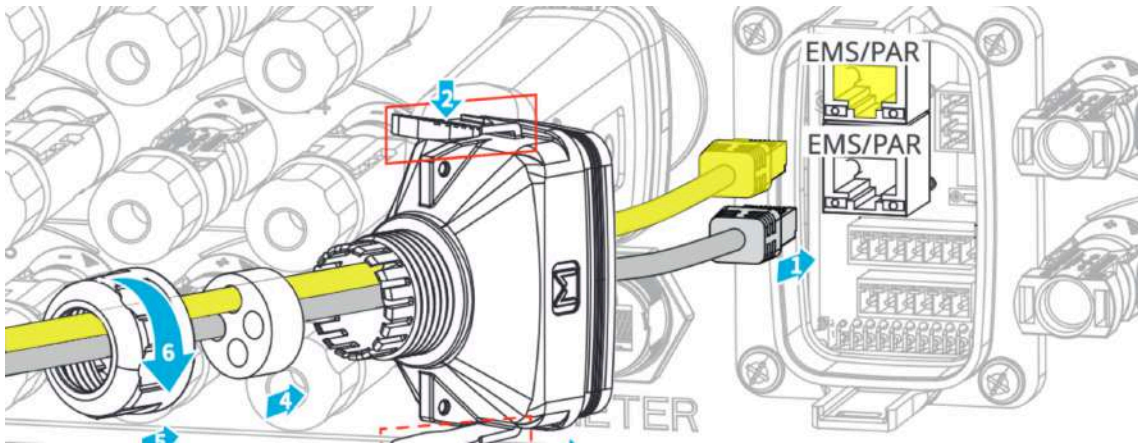

It is strongly recommended to crimp a new cable (using Clipsal 5005C305B pink double-insulated data cable) rather than using the existing gray cable that is shipped with the inverter. The GoodWe-supplied cable has a non-standard pinout which can cause confusion.

2. Use the pinout shown below on the RJ45 connector at the inverter end of the cable:

Goodwe Inverter

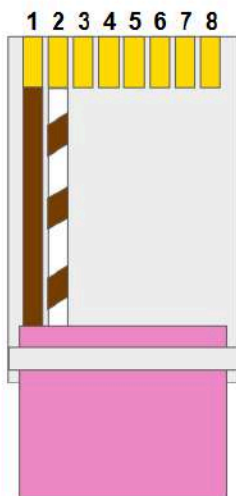

Terminate the CET device end of the cable in accordance with the [Steps to Connect to CET Device](#) section of this document.

HT Series

1. Terminate the RS485 wires into the supplied "COM 2" connector:

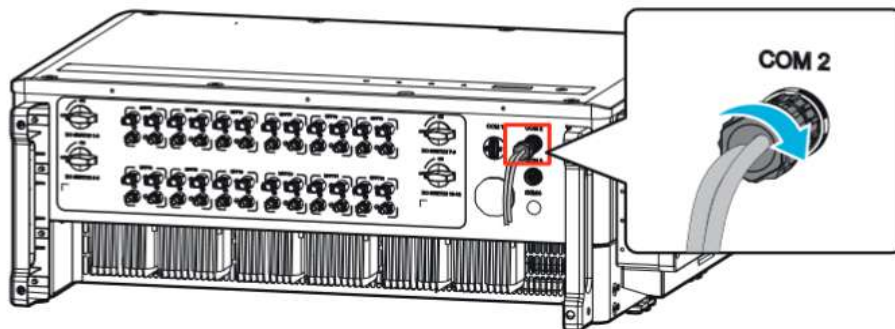

2. The pinout is:
 - **Brown wire** - "Pin 1"
 - **Brown-white wire** - "Pin 2"

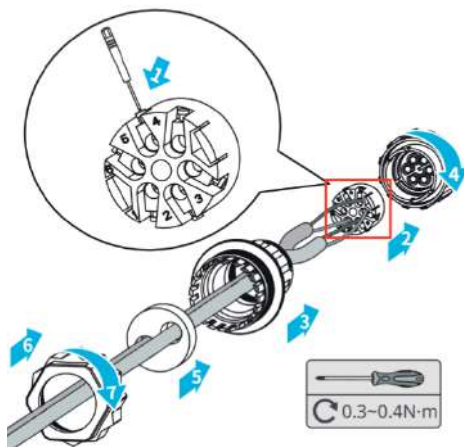
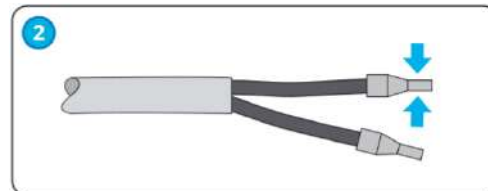
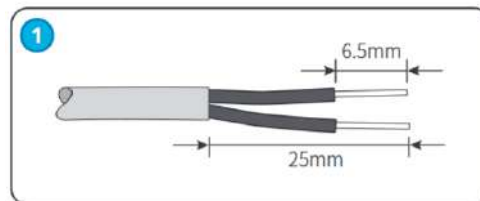

3. Terminate the CET device end of the cable in accordance with the [Steps to Connect to CET Device](#) section of this document.

MS Series

1. Terminate the RS485 wires in the green connector per the following instructions from the inverter installation manual:

The connection steps of RS485 communication of MS series are as follows:

Step 1: Screw this plate off from inverter.

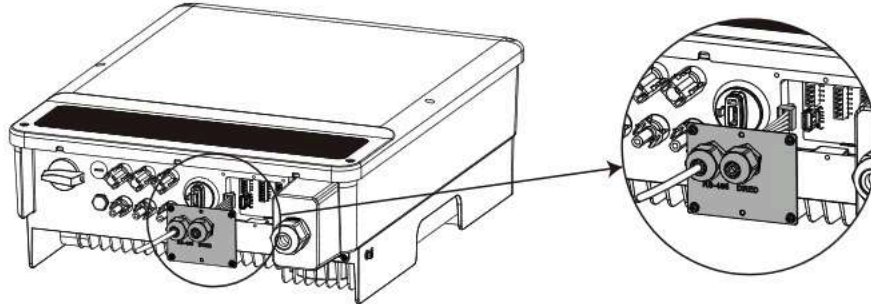

Step 2:

Put the cable through the plate.

Connect RS485 cable on the 4-pin terminal.

Advise to use cable 16AWG-26AWG.

No.	Function
1	RS485+
2	RS485-
3	RS485+
4	RS485-

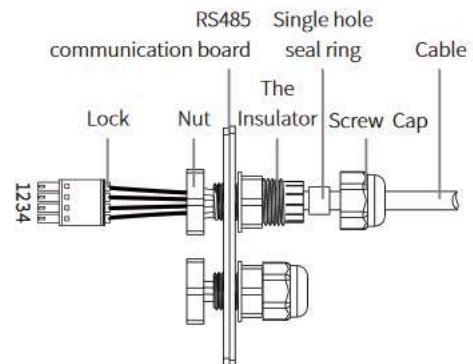

Step 3: Connect the terminal to the right position onto the inverter and screw the plate.

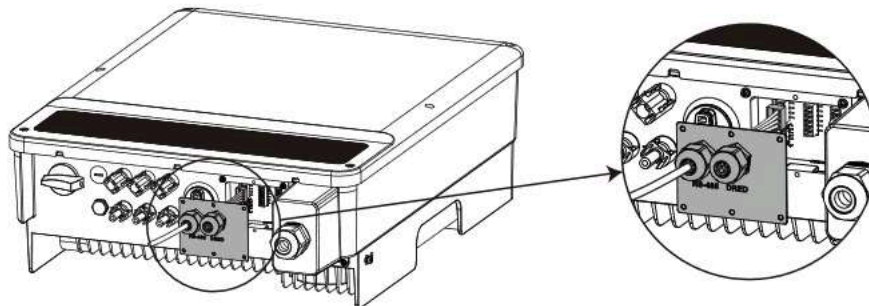

When connected, the **brown wire** should be farthest from the USB connector:

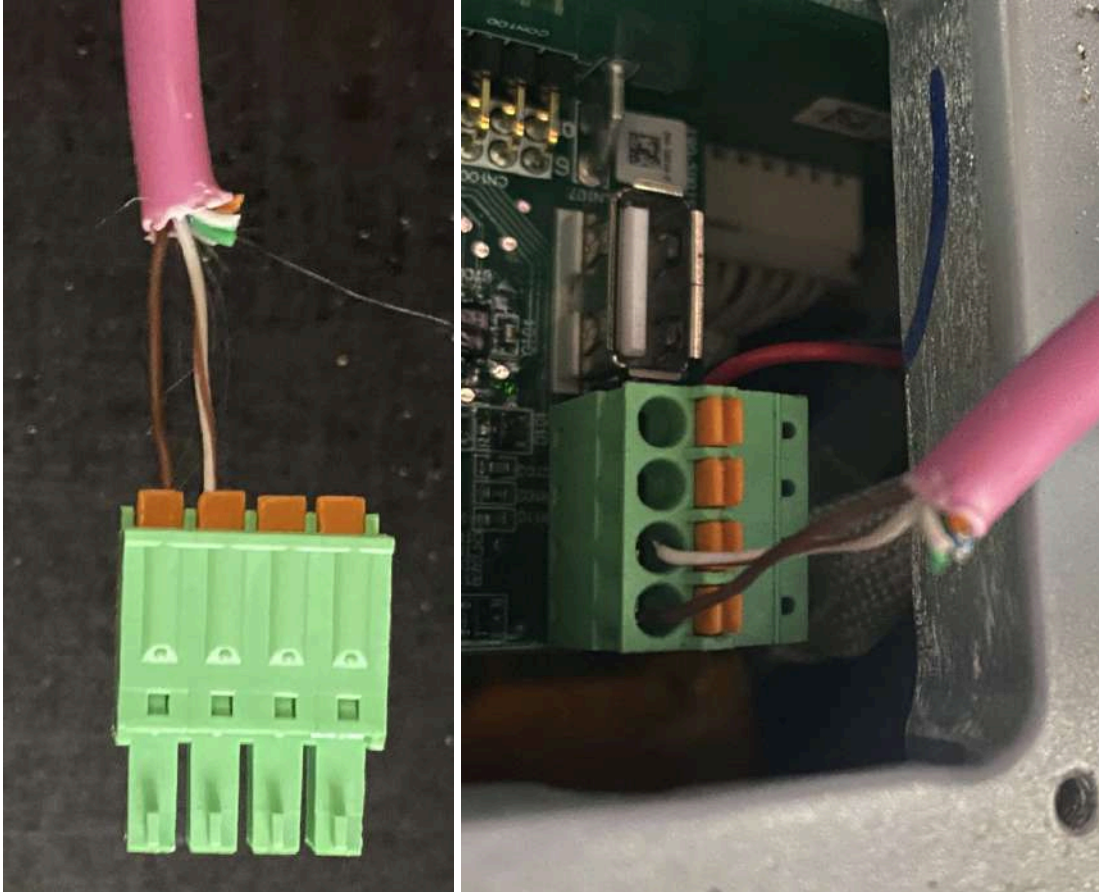



MT (30kW and lower) and SMT Series

1. Find the 6 pin connector in the inverter kit.
2. Terminate the **brown wire** into **position 1** (RS485-A1) and **brown-white wire** into **position 2** (RS485-B1).
3. Connect the 6 pin connector into the “**RS485**” port on the inverter (as below).

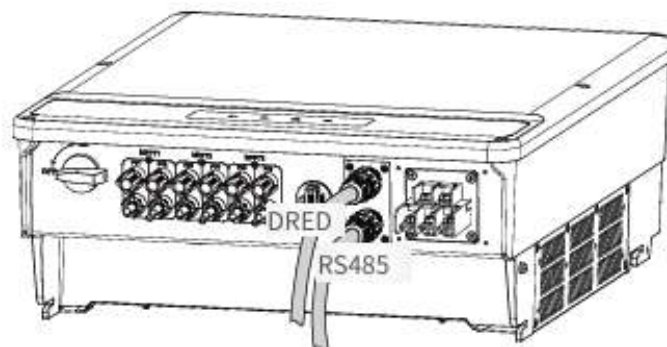
IMPORTANT: There have been cases in the MT series where the RS485 connection was established in **position 5** (RS485-A2) and **position 6** (RS485-B2). Confirming the RS485 cable is functional and the Goodwe inverter firmware has been upgraded, if the pinout above does not work, please try position 5 (brown wire) and 6 (brown-white wire).

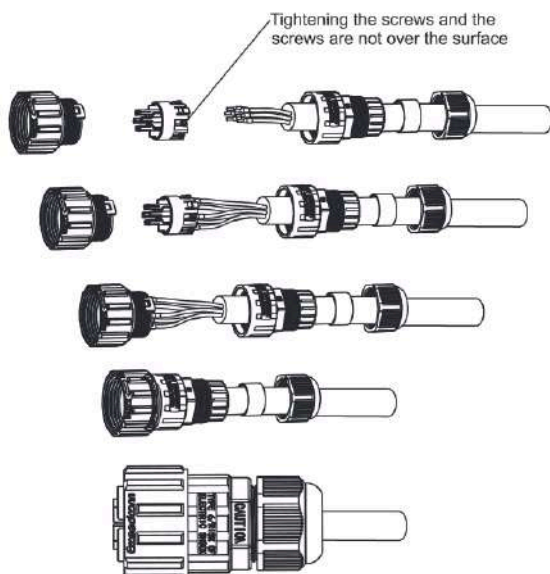

The following image summarises the standard connection options for these inverters:

 <p>5pin</p>	 <p>2pin</p>	 <p>6pin</p>
<p>Tightening the screws and the screws are not over the surface</p> 		

RS485	
NO.	Function
1(+)	SC-A
2(-)	SC-B

RS485	
NO.	Function
1	485-A1
2	485-B1
3	485-A1
4	485-B1
5	485-A2
6	485-B2

DRED	
NO.	Function
1	DRED1
2	DRED2
3	DRED3
4	DRED4
5	REF1
6	REF2

4. Terminate the CET device end of the cable in accordance with the [Steps to Connect to CET Device](#) section of this document.

MT Series (50kW and higher)

1. Remove the waterproof RS485 cover using a screwdriver
2. Remove the screw cap of the cable gland
3. Remove the one-hole sealing ring
4. Insert the RS485 cable through the components as follows: screw cap, one-hole sealing ring, insulation body and sheet metal parts
5. Terminate the wires as shown below:
 - **Brown** in position 1
 - **Brown-white** in position 2
6. Plug the green connector into the socket
7. Fasten the RS485 waterproof kit to the inverter.
8. Fasten the screw cap of the cable gland.

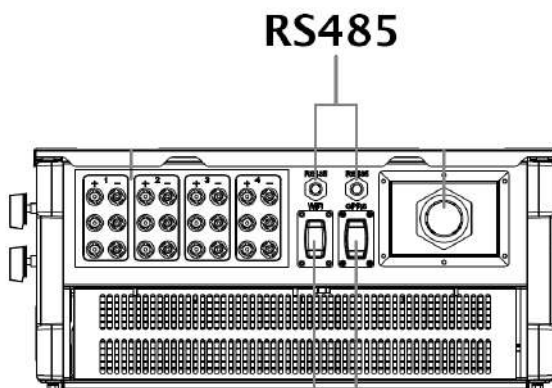

50/60/70kw

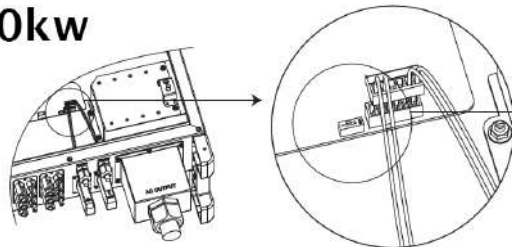
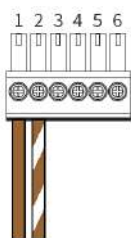

80kW

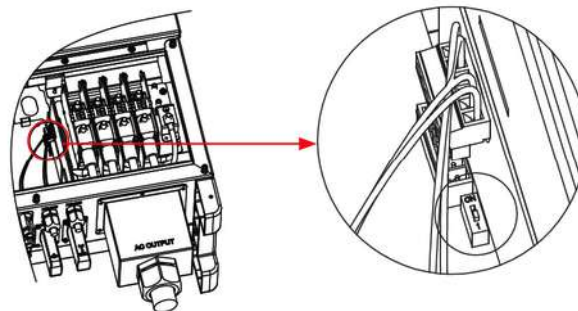
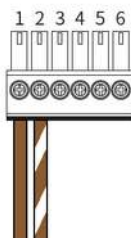

9. Terminate the CET device end of the cable in accordance with the [Steps to Connect to CET Device](#) section of this document.

SBP Series

1. Use the Back-Left port marked “Reserved RS485” / “EMS”:

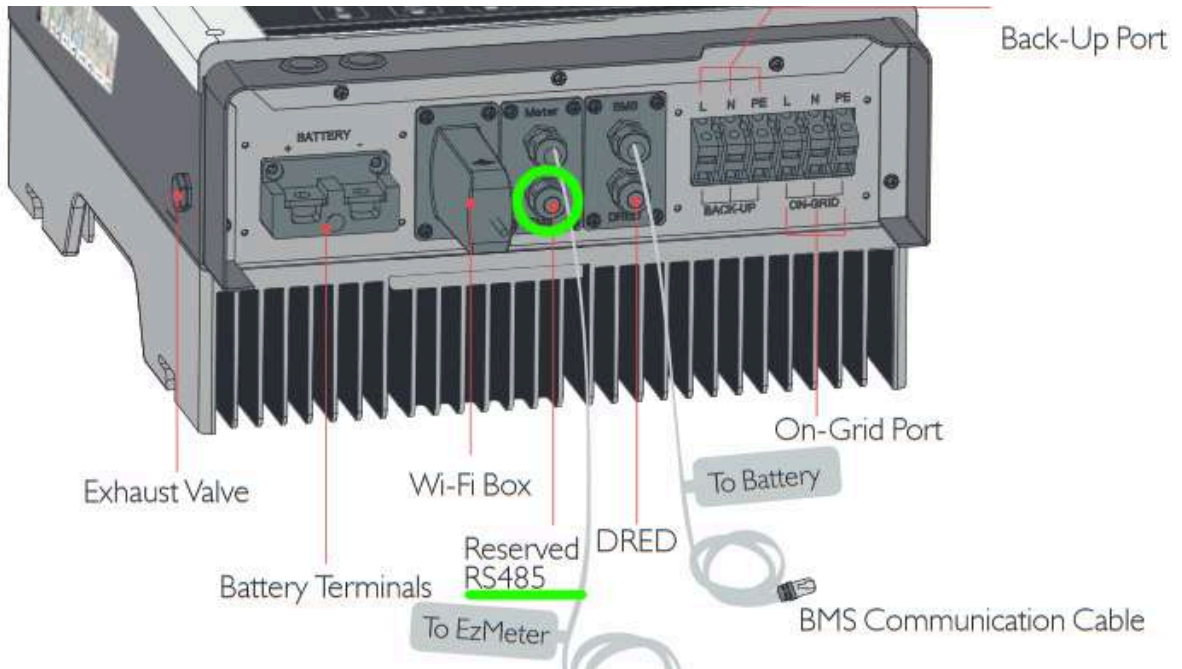

It is strongly recommended to crimp a new cable (using Clipsal 5005C305B pink double-insulated data cable) rather than using the existing gray cable that is shipped with the inverter. The GoodWe-supplied cable has a non-standard pinout which can cause confusion.

2. Use the pinout shown below on the RJ45 connector at the inverter end of the cable:

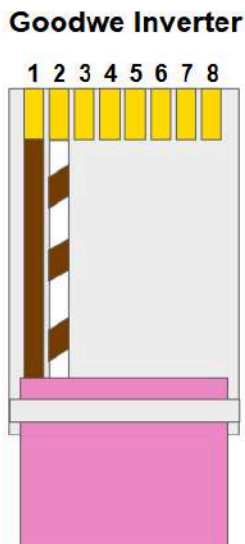

3. Terminate the CET device end of the cable in accordance with the [Steps to Connect to CET Device](#) section of this document.

SBP G2 Series (SBP-20)

4. Open the COM2 panel on the bottom of the inverter and locate the two EMS/PAR RJ45 sockets:

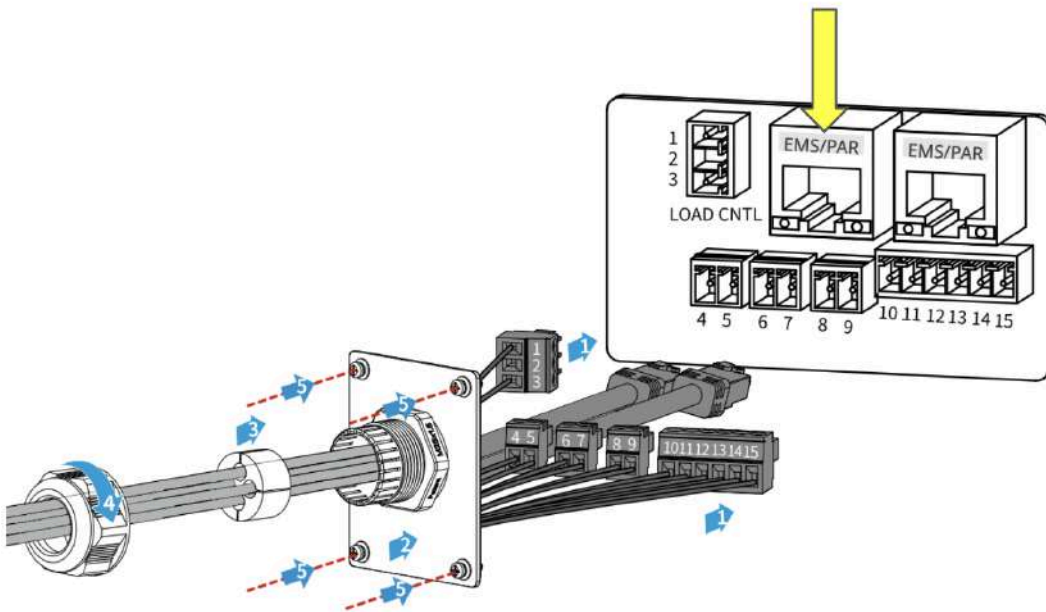

5. Use the pinout shown below on the RJ45 connector at the inverter end of the cable, and plug into one of the two EMS/PAR ports. It is strongly recommended to crimp a new cable (using Clipsal 5005C305B pink double-insulated data cable) rather than using the existing gray cable that is shipped with the inverter:

Goodwe Inverter

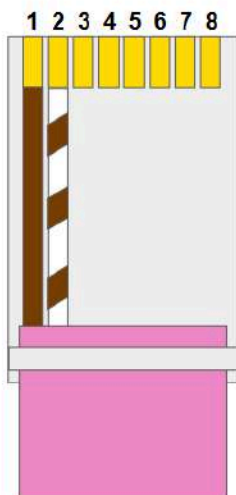

Terminate the CET device end of the cable in accordance with the [Steps to Connect to CET Device](#) section of this document.

XS Series (0.7-3kW)

1. Find the 6 pin connector in the inverter kit
2. Terminate the RS485 wires:
 - a. The **brown wire** connects to **position 6**
 - b. The **brown-white wire** connects to **position 3**
3. Connect the 6 pin connector into the “RS-485” port on the inverter

The following image summarises the standard connection options for these inverters:

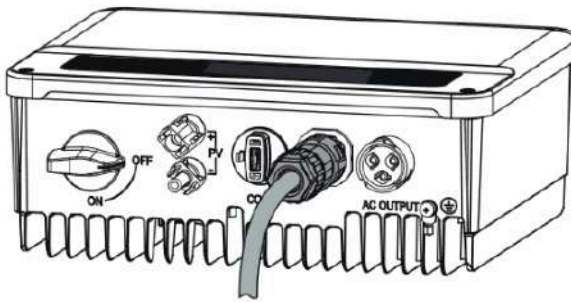

No.	Function
3	RS485-
6	RS485+
7	RS485-
8	RS485+

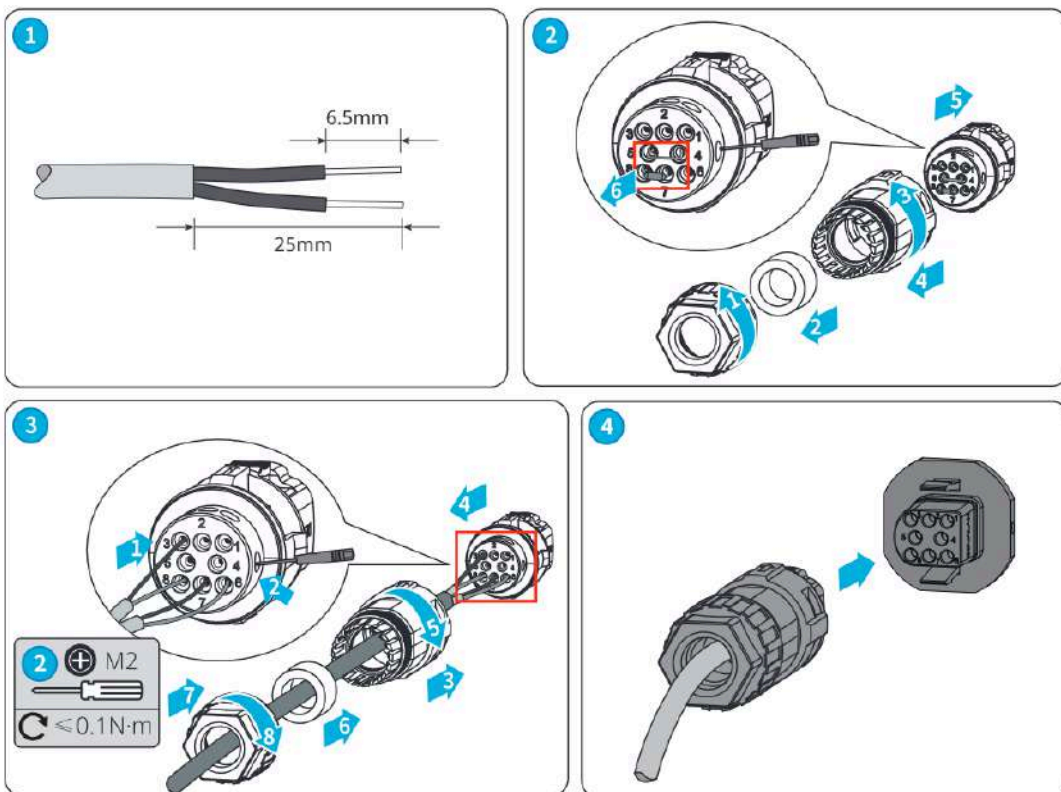

4. Terminate the CET device end of the cable in accordance with the [Steps to Connect to CET Device](#) section of this document.

Steps to Connect to CET Device

Power Meter (EMU system)

Please follow the instructions for your selected connection type: **Ethernet** or **RS485**

Ethernet

1. Using a flat blade screwdriver, carefully remove the breakout tab covering the RJ45 "Ethernet" port:

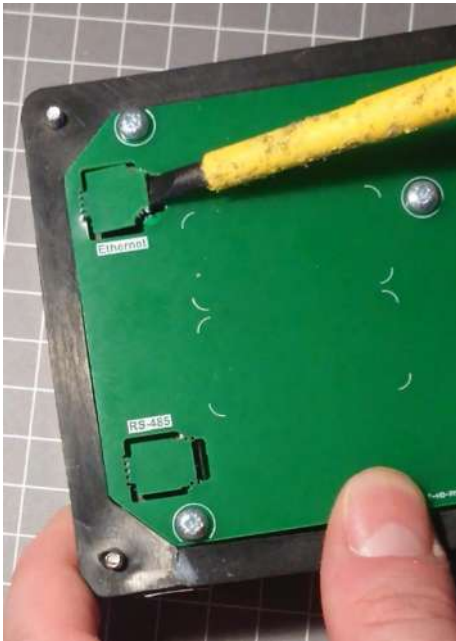

2. Connect the remote equipment to the RJ45 port using a double insulated Ethernet cable (e.g. Clipsal 5005C305B).

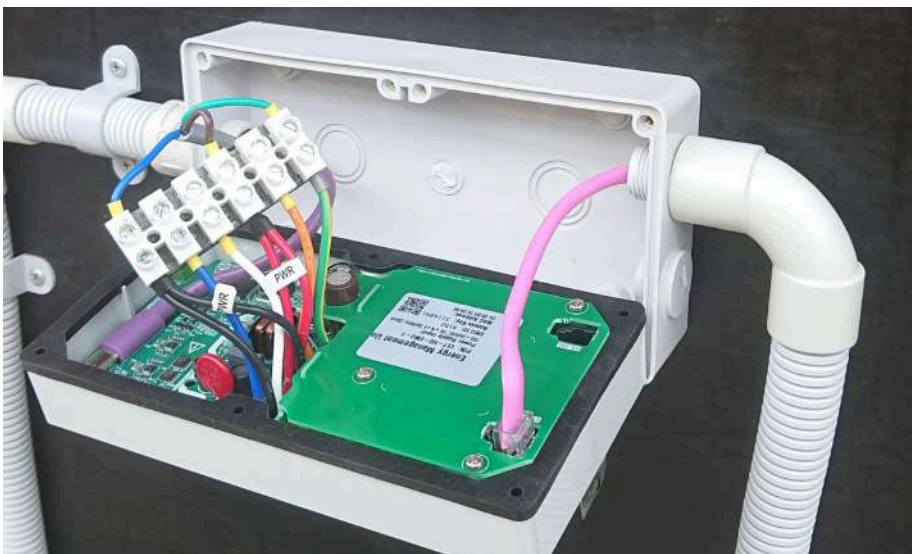

RS485

1. Using a flat blade screwdriver, carefully lever out the breakout tab covering the RJ11 "RS-485" port:



RS485 Port on CET-HD-PM2-1 Power Meter

2. Connect the remote equipment to the RJ11 6P4C port using a double insulated data cable (e.g. Clipsal 5005C305B). The pinout for the RS485 cable is shown below:

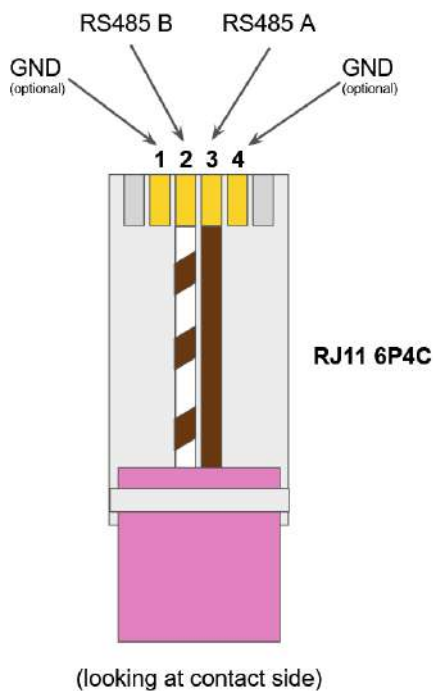

An RJ11 6P4C crimp connector is included in the standard set of accessories in the Power Meter box. An RJ12 connector would also be compatible using pins 3 & 4.

PM2 RS485 Filter for Goodwe DNS and ES G2 (ES-20) Inverters

When connecting a **CET-HD-PM2-1 Power Meter** to a **Goodwe DNS series or ES G2 series inverter** with RS485 (e.g. GW5000D-NS, GW5000-ES-20), an additional filter is required to block interference from the inverter from disrupting the Power Meter's powerline communications.

The CET-IT2-485FILT-1 RS485 filter is not supplied with the CET-HD-PM2-1 but can be ordered separately in a pack of 5 filters (PN: CET-IT2-485FILPK-1). A pack of 5 RS485 filters is included in the CET Installer Kit (PN: CET-HD-INST-KIT-1).



To install the RS485 filter, connect the RJ11 connector to the RS485 port on the CET-HD-PM2.

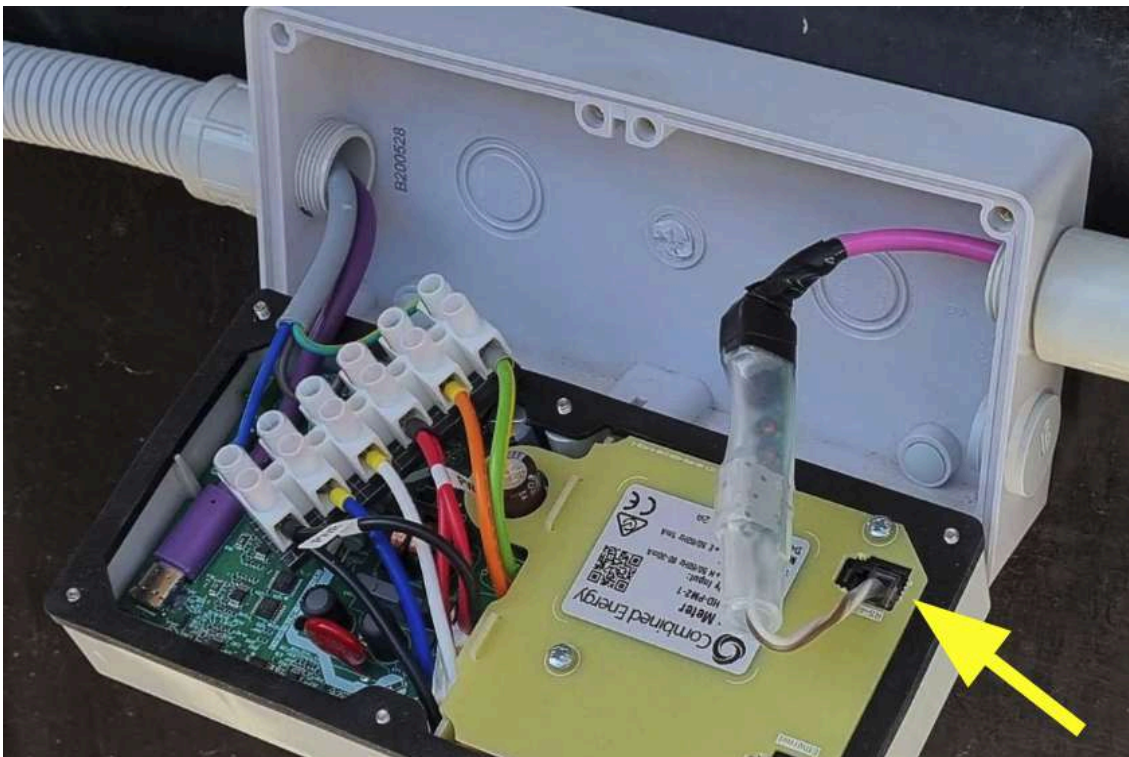

Terminate the **brown wire** from the Inverter to the data positive "+" INV terminal of the RS485 filter, and the brown-white wire to the data negative "-" INV terminal.

Strip 11mm of insulation from the wires before termination:

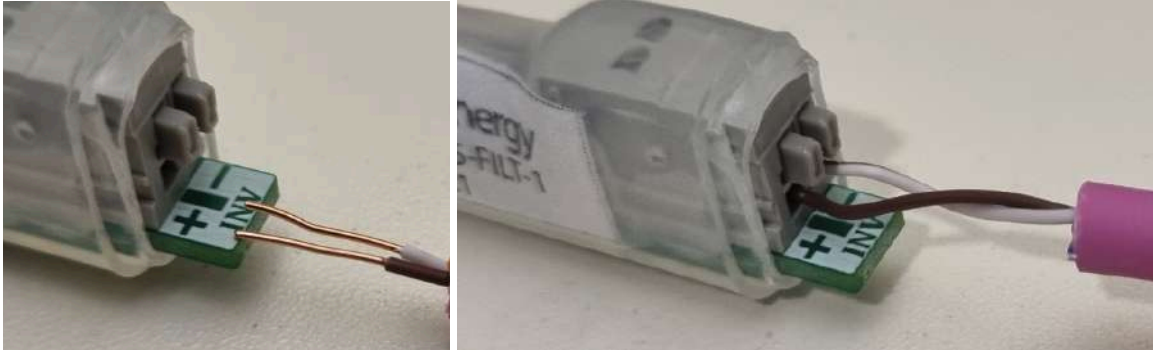

Wrap the terminated wires in **6 layers of electrical tape** to ensure the finished assembly is properly insulated:



Gateway One

Ethernet

Terminate the **double-insulated** Ethernet cable with a standard T568A or T568B pinout (to match the inverter end), and plug the cable into the Ethernet port on the **far right-hand side** of the Gateway:

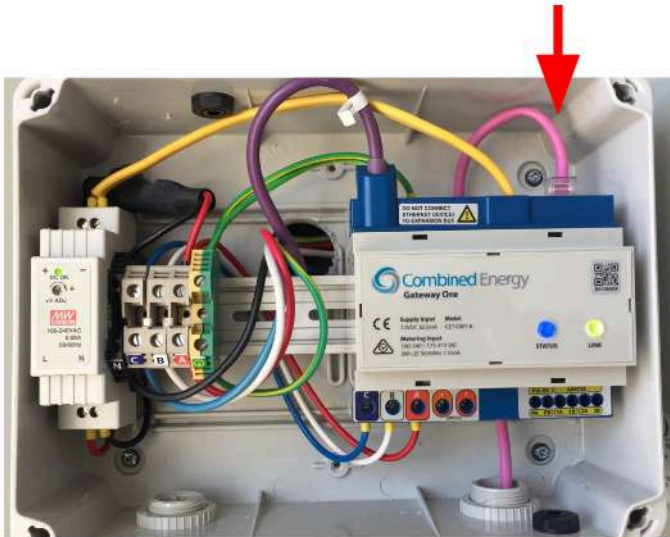

RS485

1. Terminate the double-insulated data cable with an RJ45 using the pinout shown below. Only the **brown** and **brown-white** wires are required for RS485:

Gateway Expansion Bus

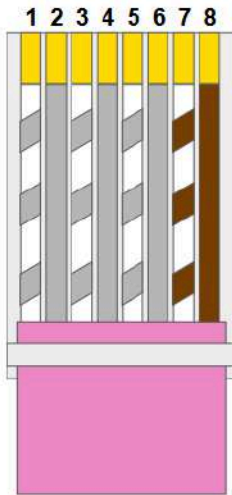

2. Plug the RJ45 connector into either of the two expansion bus ports on the top of the Gateway One:

